Wheel Balancer Manual





Warning

- This manual is a necessary part of the product. Please read carefully.
- Keep the manual for later use when maintaining the machine.
- This machine can only be used for the designated purposes. Never use it for any other purpose.
- The manufacturer is not responsible for the damage incurred by improper use or use other than the intended purpose.

Precaution

- The equipment can only be operated by qualified personnel with special training. Modification to any components or parts, or use the machine for other purpose without either obtaining the agreement from the producer, or observing the requirement of the instructions may lead to direct or indirect damage to the equipment.
 - ★ The equipment should be installed on the stable ground, not wooden pallet, otherwise not accurate.
- Keep the back panel 0.6M away from the wall for good ventilation. Enough room should be left on both sides for convenient operation.
- Do not put the equipment a place with high temperature or moisture, or near the heating system, water tap, air-humidifier or chimney.
 - Avoid lots of dust, ammonia, alcohol, thinner or spraying binder.
 - People who are no operating the machines should be kept away when it is used.
 - Use appropriate equipment and tools, protective and safety equipment, including eyeglasses, earplugs and working boots.
- Pay special attention to the marks on the machine.
- Do not touch or approach the moving parts by hand during operating.
- Do not remove the safety device or keep it from working properly.

Contents

1. General-----	1
2. Machine assembly-----	1
3. Controls and components-----	3
4. Indication and use of wheel balancer-----	6
5. Self-calibration of wheel balancer -----	10
6. Errors-----	11
7. Self- diagnoses-----	12
8. Setting machine-----	12
9. OPT function -----	13
10. Spare parts list and Exploded drawings-----	15

1. General

1.1. Technical data:

Power Supply Voltage 110 V, 60 Hz, 1 Ph
 Motor 0.34 HP (0.25 kW)
 Working Temperature 23 ° F to 122 ° F (-5 ° C to 50 ° C)
 Cycle Time 6 to 9 seconds
 Data Entry Keypad
 Balancing Modes Dynamic / Static / Alloy
 Certification CE Approved
 Rim Diameter Capacity 10" - 24" (254 mm - 610 mm)
 Rim Width Capacity 1 1/2" - 16" (38 mm - 406 mm)
 Max. Wheel Diameter 39 3/8" (1000 mm)
 Max. Wheel Weight 154.32 lbs (70 kg)
 Shaft Size 36mm
 Max. Shaft Weight 176.37 lbs (80 kg)
 Balancing Speed 180 RPM
 Accuracy 0.035 ounces (1 gram)
 Display Standard or Metric
 Self Calibration Yes
 Power Cord Length 78 47/64" (2000mm)
 Noise Level < 70 dB
 Product Dimensions L 41.73" x W 26.18" x H 40.55" (1060 mm x 665 mm x 1030 mm)
 Product Weight 182.98 lbs (83 kg)

1.2. Features:

- ALU balancing mode may choose 9 o'clock or 12 o'clock position to add weight
- Statistic and dynamic balancing, ALU-programs for alloy rims or special shaped
- Self diagnoses, easy to find the problem
- Apply to steel and aluminum alloy rim

1.3. Working environment:

- Temperature: 5~50°C
- Height: ≤4000m

2. Machine assembly

2.1. Unpack

Unpack the carton, check if missing any spare parts.

No.	Item	Qty
1	Width gauge	1
2	Conic No.1	1
	Conic No.2	1
	Conic No.3	1
	Conic No.4	1

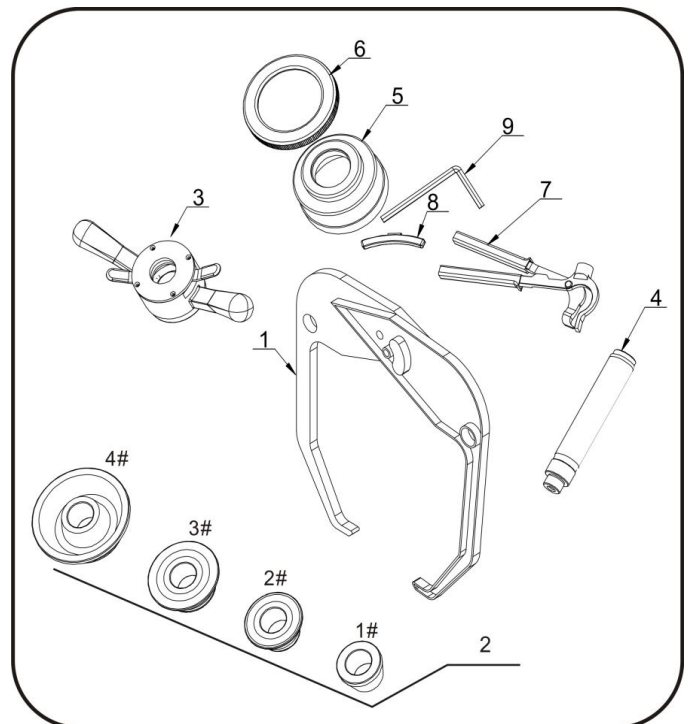

3	Quick release nut	1
4	Thread hub	1
5	Bowl for quick nut	1
6	Pad for bowl	1
7	Balancing hammer	1
8	100g weight	1
9	Allen wrench	1

2.2. Install

- The equipment should be installed on the stable ground, not wooden pallet, otherwise not accurate.
- Keep the back panel 0.6M away from the wall for good ventilation. Enough room should be left on both sides for convenient operation.

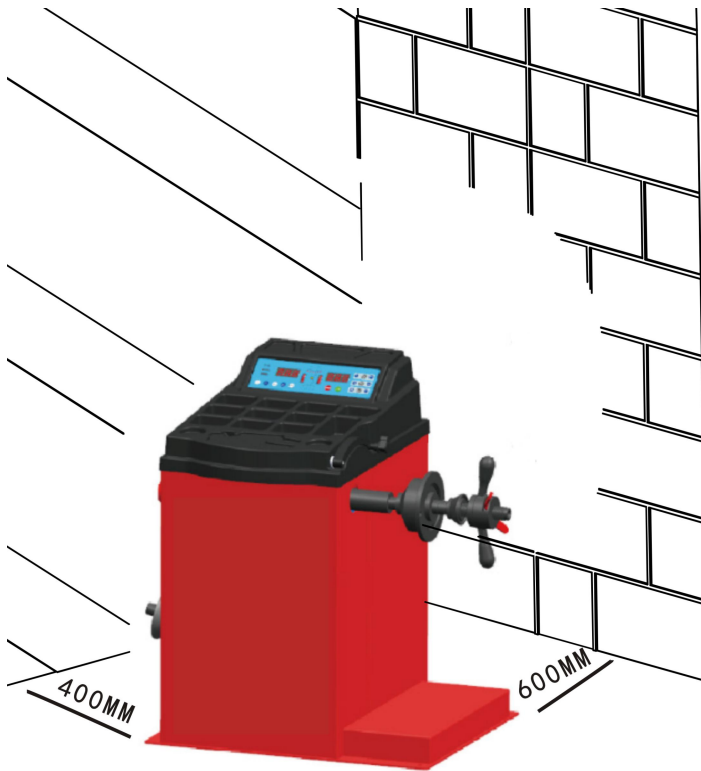

2.3. Fix balancer to floor with screws on the bottom.

2.4. Install adaptor

The wheel balancer is supplied complete with cone type adaptor for fastening wheel with central bore. (see below picture)

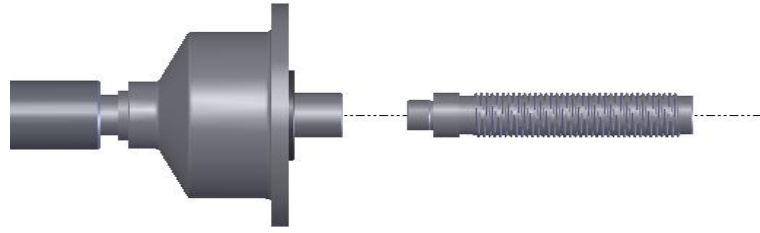

2.5. Install wheel

Clean wheel, take off counterweights, check pressure of wheel.

Choose the way of installation according to the type of wheel.



Main shaft-wheel—
suitable cone(small head towards inside)—quick handle nut

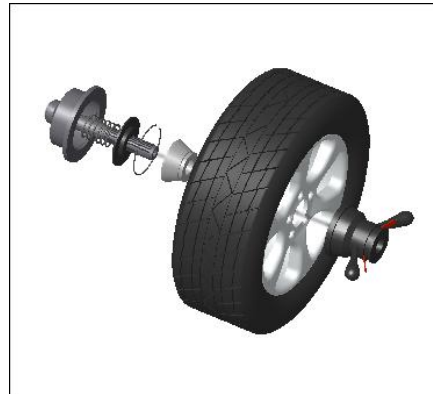

Main shaft-suitable cone(big head towards inside)
—wheel—quick handle nut





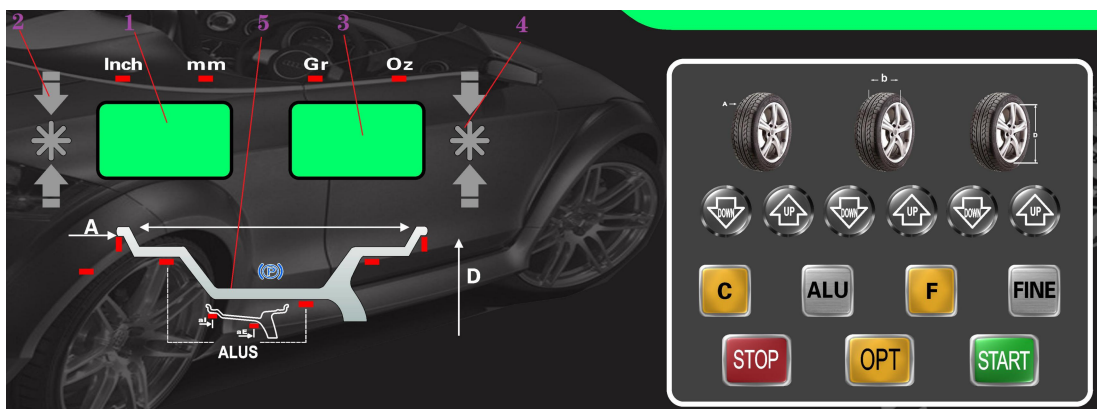

Attention: May add a wheel, and hold the wheel to help install the thread hub. When installing or taking off wheel, do not let wheel move on the shaft, to avoid scratching shaft.

Display plate (G)

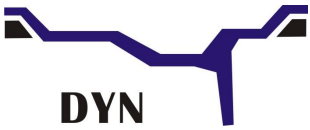





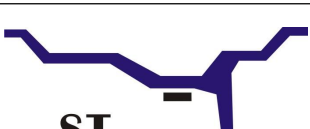





- 1.inside unbalance value digital display
- 2.inside unbalance position display
- 3.outside unbalance value digital display
- 4.outside unbalance position display
- 5.displays showing type of correction chosen.

Eight balancing modes

Icon	Balancing mode	Operation	Add weights
 DYN	Standard/Default	<ol style="list-style-type: none"> 1. Turn on machine 2. Input a,b,d value 3. Start spin, after spin stop 	Clip on weights on both sides of rim edge
 ALU-1	ALU1	<ol style="list-style-type: none"> 1. Turn on machine 2. Input a,b,d value 3. Press ALU button, indicator lit up 4. Start spin, after spin stop 	Add adhesive weights on the rim shoulder both sides
 ALU-2	ALU2	<ol style="list-style-type: none"> 1. Turn on machine 2. Input a,b,d value 3. Press ALU button, indicator lit up 4. Start spin, after spin stop 	Clip on weight on inside rim edge, add adhesive weight on outside rim shoulder
 ALU-3	ALU3	<ol style="list-style-type: none"> 1. Turn on machine 2. Input a,b,d value 3. Press ALU button, indicator lit up 4. Start spin, after spin stop 	Add adhesive weights on the rim shoulder both sides
 ALU-4	ALU4	<ol style="list-style-type: none"> 1. Turn on machine 1. Input a,b,d value 2. Press ALU button, indicator lit up 3. Start spin, after spin stop 	Clip on weight on inside rim edge, add adhesive weight on outside rim shoulder
 ALU-5	ALU5	<ol style="list-style-type: none"> 1. Turn on machine 2. Input a,b,d value 3. Press ALU button, indicator lit up 4. Start spin, after spin stop 	Add adhesive weight on inside rim shoulder, clip on weight on outside rim edge
 ALU-S	ALUS	<ol style="list-style-type: none"> 1. Turn on machine 2. Press ALU button, indicator lit up 3. Input aI,aE,d value 4. Start spin, after spin stop 	Add adhesive weights on the two positions gauge head touch
 ST	Static mode, for motorcycle wheels	<ol style="list-style-type: none"> 1. Turn on machine 2. Input a,b,d value 3. Press ALU button 4. Start spin, after spin stop 	Add adhesive weight

Key board (H)

Icon	Function	Icon	Function
	Set distance		Optimization of unbalance

	Set rim width		Selection of “ALU” modes
	Set rim diameter		Static mode, for motorcycle wheels
	Recalculation		Unbalance display pitch and threshold
	Start		Stop/Cancel

4. Indication and use of wheel balancer

4.1. DYN (Standard/Default) mode

4.1.1. Clean wheel, take off counterweights, check pressure of wheel. Choose the way of installation according to the type of wheel.



Main shaft—wheel—
suitable cone(small head towards inside)—quick handle nut

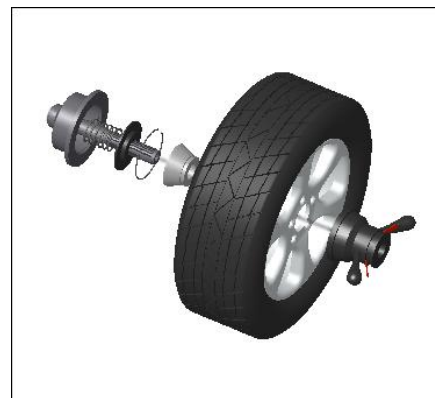

Main shaft—suitable cone(big head towards inside)
—wheel—quick handle nut

Attention: May add a wheel, and hold the wheel to help install the thread hub. When installing or taking off wheel, do not let wheel move on the shaft, to avoid scratching shaft.

4.1.2. Turn on machine

4.1.3. Input a b d value

Turn on machine, choose right way to install wheel according to the type of wheel. Set “a” “b” “d” values:

- set “a” value: move the gauge to measuring position as illustrated as Fig.1, hold the gauge still in position for approx. 4 seconds, successful memorization is given, then return the gauge to position

0.(The value measured in automatic mode appear on the display). Or press **a+** and **a-** to set manually.

● set “b” value: set nominal diameter “b” marked on the wheel or use the width gauge to measure the value of ”b” as Fig.2, then press **b+** and **b-**.

● set “d” value: this value measured in automatic mode same time as “a” value setting, or press **d+** and **d-** to set manually.

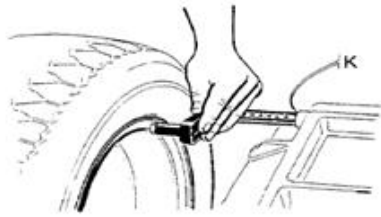

Fig.1



Fig.2

4.1.4. Put down the guard and press **START** to perform a measuring spin.

4.1.5. In a few seconds the wheel is brought to operating speed and begin measuring unbalance, the unbalance values remain on instruments 1 and 3 when the wheel stopped. Press **FINE** may check the real unbalance value under threshold.

4.1.6. Anticlockwise moving wheel slowly, until the right LED lit up full, clip weight on 12 o'clock position (Fig.3)

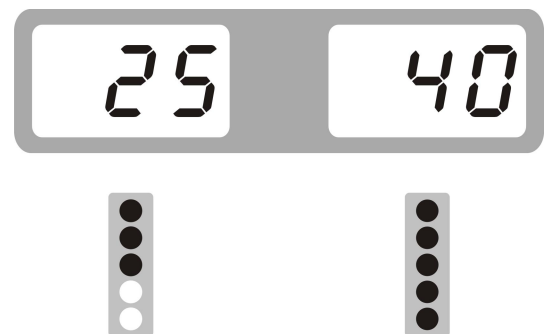
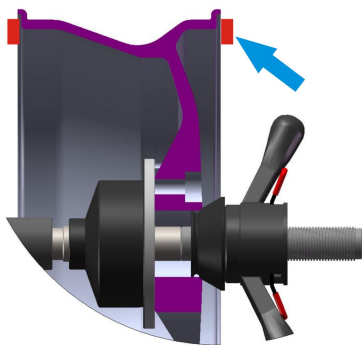

Fig. 3

4.1.7. Anticlockwise moving wheel slowly, until the left LED lit up full, clip weight on 12 o'clock position (Fig.4)

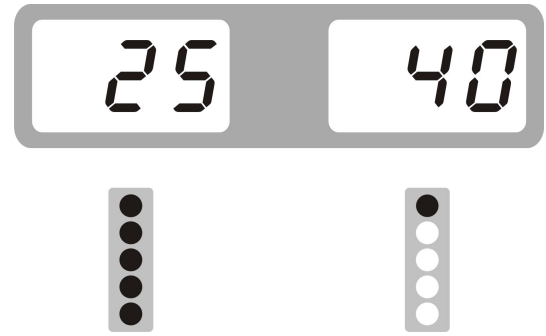
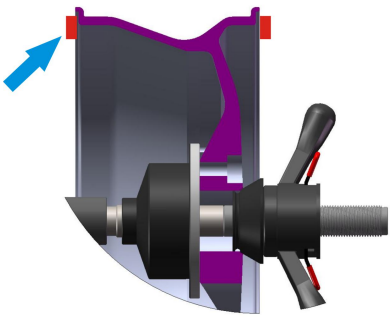

Fig. 4

4.1.8. After finishing clipping the counterweights, put down the guard or press **START**, to perform balancing spin again, if comes out 00 00, means balancing succeed. (Fig.5)



Fig. 5

4.2. ALU-1 mode (ALU-1, ALU2 same operation, only the position to add weights different)

4.2.1. Set “a” “d” “b” values

4.2.2. Press **ALU** until ALU1 indicator lit up

4.2.3. Put down the guard and press **START** to perform a measuring spin.

4.2.4. In a few seconds the wheel is brought to operating speed and begin measuring unbalance, the unbalance values remain on instruments 1 and 3 when the wheel stopped. Press **FINE** may check the real unbalance value under threshold.

4.2.5. Anticlockwise moving wheel slowly, the displays with right LED’s lit up full indicate the correct angular position where to mount the counterweights, 12 o’clock position (9H=Off) or 9 o’clock (9H=On) position outside, as Fig.6, add the counterweight.

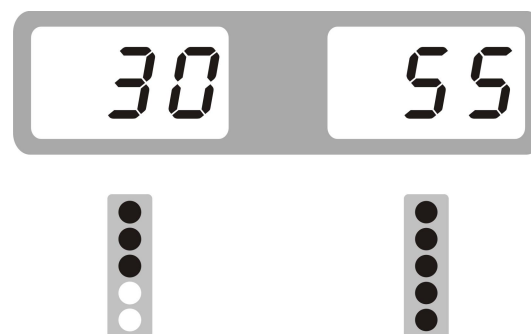
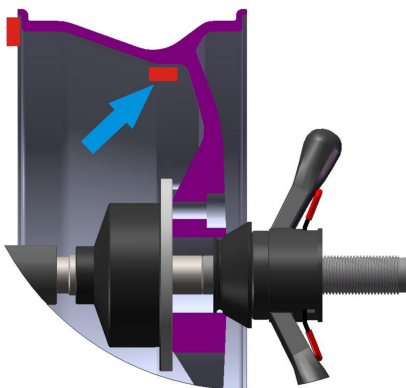

Fig. 6

4.2.6. Anticlockwise moving wheel slowly, the displays with left LED’s lit up full indicate the correct angular position where to mount the counterweights, 12 o’clock position (9H=Off) or 9 o’clock (9H=On) position inside, as Fig.7, add the counterweight.

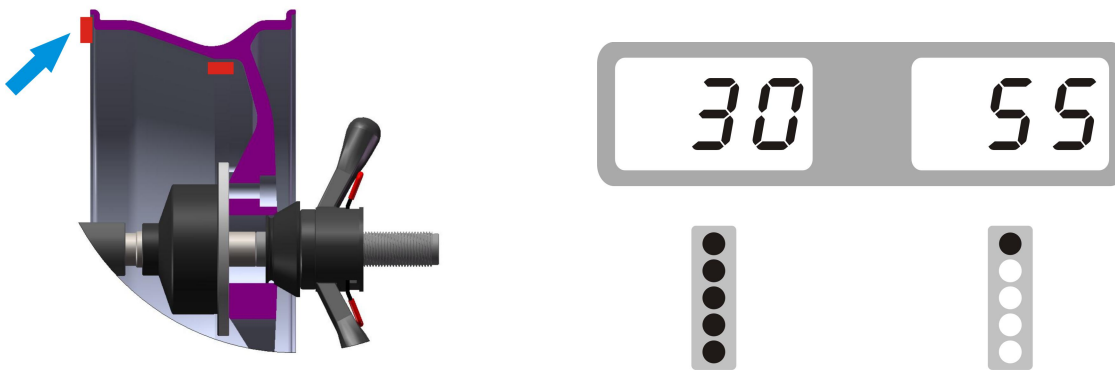

Fig. 7

4.2.7. After finishing mounting the counterweights, put down the guard and press **START**, to perform balancing spin again, if comes out 00 00, means balancing succeed. (Fig.8)



Fig. 8

4.3. ALU—S mode

This mode is used for special rim, if ALU1/ALU2 can not be used, you should choose ALUS mode.

Input aI, aE, d value

- Set “aI”: pull gauge out let the gauge head touch the position of FI for 4 seconds, may press **a+** and **a-** to change
- Set “aE”: pull gauge out let the gauge head touch the position of FE for 4 seconds , may press **b+** and **b-** to change
- Set “d”: read from rim, press **d+** and **d-** to input

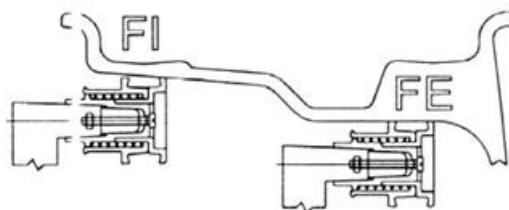

Fig. 9

Put down the guard and press **START** to perform a measuring spin.

4.3.1. 12 o'clock position to add weight

Set SLC as OFF according to 8.1

Anticlockwise moving wheel slowly, until the right LED lit up full, add weight on 12 o'clock position (Fig.10)

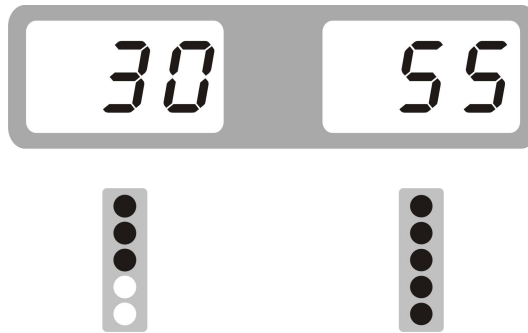
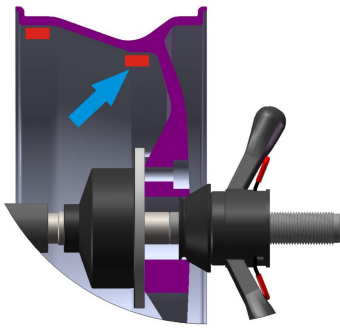

Fig. 10

Anticlockwise moving wheel slowly, until the left LED lit up full, add weight on 12 o'clock position (Fig.11)

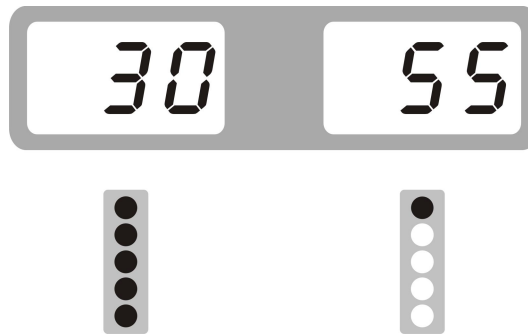
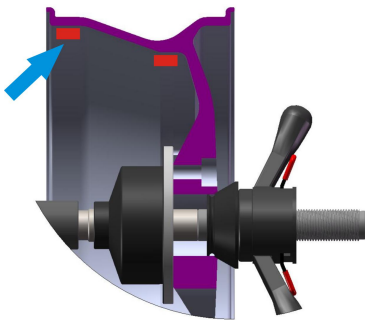

Fig. 11

After finishing mounting the counterweights, put down the guard and press **START**, to perform balancing spin again, if comes out 00 00, means balancing succeed. (Fig.12)



Fig. 12

4.3.2. Use gauge head to add weight

Set SLC as ON according to 8.1

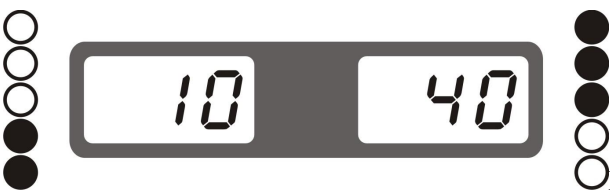

Fig. 13

Anticlockwise moving wheel slowly, until the right LED lit up full (Fig.14)

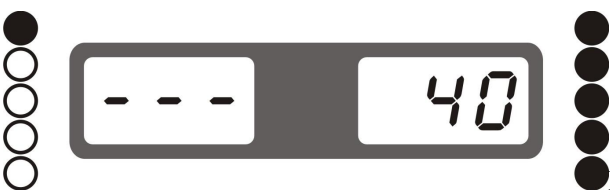

Fig. 14

Take off proper counterweight to be hold by the gauge head as Fig. 16

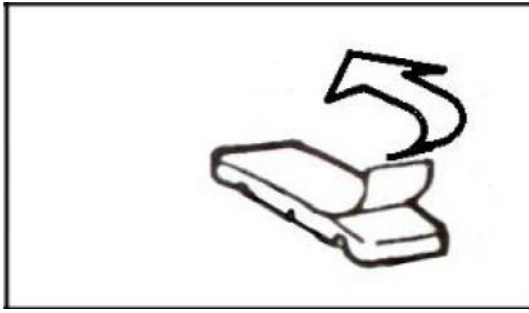

Fig. 15

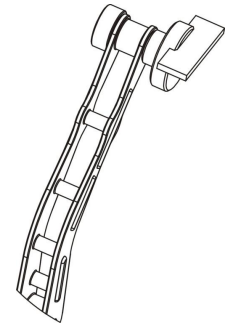

Fig. 16

Pull out gauge until there is a square comes in the middle window (Fig. 17)

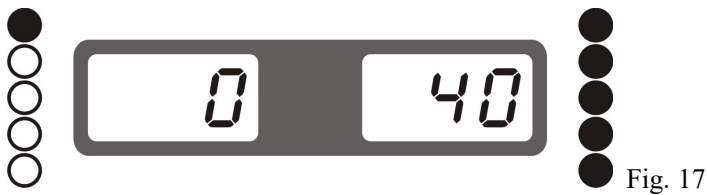

Fig. 17

Release the counterweight and let it stick on rim (Fig. 18)

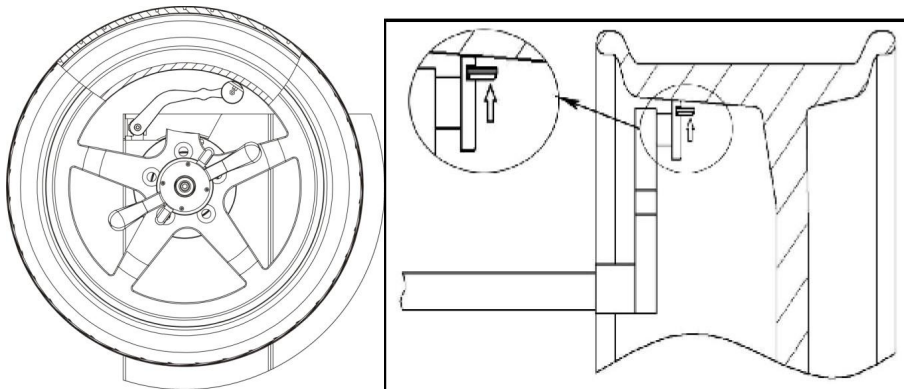

Fig. 18

Anticlockwise moving wheel slowly, until the left LED lit up full (Fig.19)

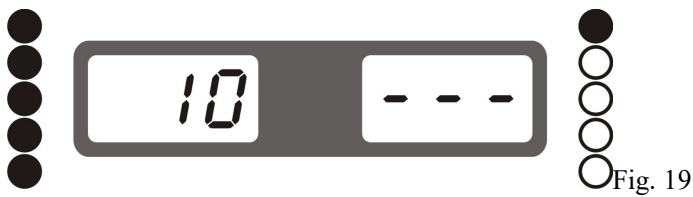

Fig. 19

Take off proper counterweight to be hold by the gauge head as Fig. 16
Pull out gauge until there is a square comes in the middle window (Fig. 20)



Fig. 20

Release the counterweight and let it stick on rim (Fig. 21)

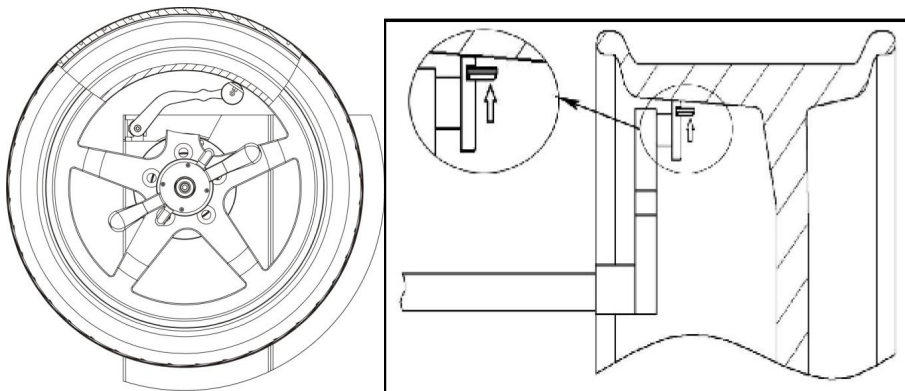

Fig. 21











Then turn down safe guard and press **START** to start spin, comes Fig. 22 means the wheel is balanced.





Fig. 22

4.ALUS split function

Note: Only ALU-S mode can use this function. And Operator must be experienced.

Step 1	In the ALU-S mode, the results of the case, after the 	comes>	
Step 2	Through   input wheel number, and then press 	comes>	
Step 3	Keep any one of spoke on the position of 12 o'clock, press 	comes>	
Step 4	Anticlockwise rotate wheel by hand slowly, until the right SP1 LED lit up full, add the adhesive weight (to stick the weights on position of 12 o'clock or 9 o'clock depends SLC=On or Off)	comes>	
Step 5	Anticlockwise rotate wheel by hand slowly, until the outside SP1 lit right SP2 LED lit up full, add the adhesive weight (to stick the weights on position of 12 o'clock or 9 o'clock depends SLC=On or Off)	comes>	









Step 6	Put down safe guard and press  , after spin stop	comes >	
Operation completed			

5. Self-calibration of wheel balancer







5.1. Self-calibration of wheel balancer

5.2. Turn on balancer, install a medium size wheel (14"-18") which can use clip-on weight, set "a b d" value, then

Do the self-calibration whenever you think the balancer is not accurate. The 100g weight must be accurate.





Step 1	Press  and hold, then press 	comes	
Step 2	Put down safe guard or press  start spin, after spin stop	comes	
Step 3	Open the safe guard and clip a 100 gram weight on the outside 12 o'clock position, put down safe guard and press  to start spin, after spin stop	comes	
Step 4	Open the safe guard and clip a 100 gram weight on the inside 12 o'clock position, put down safe guard and press  to start spin, after spin stop	comes	
self-calibration finished			

6. Rim distance gauge calibration

	comes >	
pull gauge to position "0" and hold, press 	comes >	
pull gauge to position "15" and hold, press 	comes >	
Rim distance gauge calibration finished		



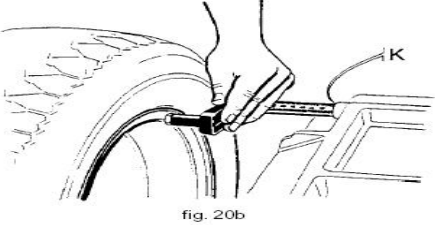

7. Rim diameter gauge calibration

Set “d” by press **d+** and **d-**, (for example if it is 14 inch, make it 14)

	comes >	
<p>move gauge to touch the edge of rim and keep still</p> 	>	<p>Press </p>
comes >		
Rim diameter gauge calibration		

8. Errors

Various abnormal conditions can arise during machined operation by the microprocessor, if comes the errors, must stop operation, find the reason and the solution according, if the error persists, consult the supplier.

No.	Errors	Reasons	Solution
1		1. No spin 2. Shaft spin	1. If no spin, check or change power board 2. If spin, check or change position pick up board and computer board 3. Adjust position pick up board support
2		1. No wheel or wheel not locked tightly 2. Position pick up board problem	1. Lock tightly 2. check or change position pick up board
3		1. No enough pressure in wheel 2. Wheel distortion	1. Add proper pressure in wheel 2. Check wheel
4		1. Position pick up board problem 2. Computer board problem	1. Check or change position pick up board 2. Check or change computer board
5		1. Micro switch problem 2. Computer board problem	1. Check or change Micro switch 2. Check or change computer board

6		1. Power board problem 2. Computer board problem	1. Check or change power board 2. Check or change computer board
7		1. Program lost 2. Computer board problem	1. Self calibration 2. Check or change computer board
8		1. No add 100g weight during self calibration 2. Computer board problem 3. Power board problem	1. Add 100g weight 2. Check or change computer board 3. Check or change power board
9		1. Micro switch problem 2. Computer board problem	1. Check or change micro switch 2. Check or change computer board
10		1. Computer board problem 2. Power board problem	1. Check or change computer board 2. Check or change Power board

9. Self- diagnoses

Press **F** and hold, then press **FINE** goest to self diagnoses, press **ALU** to next , press **STOP** to escape

Order	Display	Function	Function normal
1		Display	All lit up
2		Position pick up board	POS changes in 0-127
3		Distance potentiometer	Left window data is 327-340, when pull gauge out, the data changes
4		Diameter potentiometer	left window data is 327-340, turn ruler to another direction, data changes
5		Width potentiometer(if provide)	left window data is 327-340, turn ruler to another direction, data changes
6		Pressure sensor	Use hand to press main shaft, 4X-4X 6X-6X changes

10. Setting machine

10.1. Machine setting

Press **STOP** and hold, then press **C** goes to set machine, press **b+** and **b-** to change, press **a+** to next

Order	Display	function	choice
1		Unbalance display threshold	5/10/15
2		Sound	On/off
3		Light	1-8
4		Inch/mm	inch on/inch off
5		9 o'clock position for adhesive weight	9 o'clock position/12 o'clock position
6		When ALU-S mode if use gauge head to add weight	OFF: 12 o'clock position, no use of gauge head to add weight ON: Use gauge head to add weight
7		Tire weight	On/off

10.2 Safe guard setting

Press and hold, then press to set safe guard

Display	Function	Explain
	Safe guard on	Put down safe guard to start spin
	Safe guard off	Put down safe guard then press to start spin

10.3 Unit of weight setting









Press + to set safe guard

Display	Function	Explain
	Unit of weight	Gram
	Unit of weight	Ounce

11. OPT function

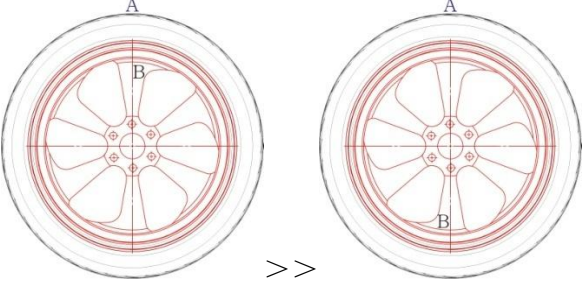
Note: When unbalance value is too much, choose OPT, and operator must be experienced.

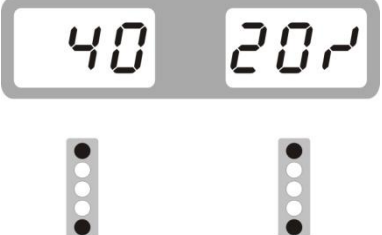
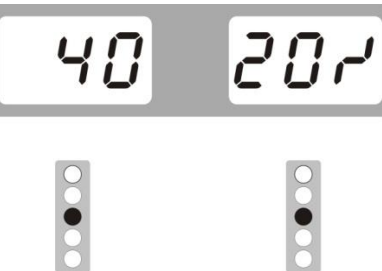
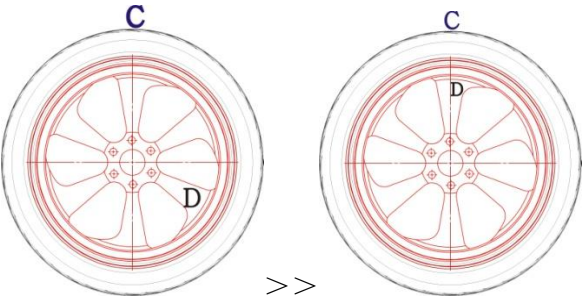
Install wheel, input a b d value

1	Press 	comes >	
2	Put down safe guard and press 	comes >	
3	With the help of tire changer, change the rim and rubber 180 degree	reference >	
4	Then put down safe guard and press 	comes >	
5	Rotate wheel until four indicators lit up (two on both sides, the dark spot in the right side picture), mark the position C with chalk on rubber	reference >	
6	Rotate wheel until two indicators lit up (one on both sides, the dark spot in the right side picture), mark the position D with chalk on rim	reference >	
7	With the help of tire changer, change the rim and rubber to make C and D match	reference >	
8	Put down safe guard and press 	comes >	If unbalance is less than before, OPT succeed